

# Math 254: Introduction to Linear Algebra

## Notes #0.1 — Introduction

Peter Blomgren  
(blomgren@sdsu.edu)

Department of Mathematics and Statistics  
Dynamical Systems Group  
Computational Sciences Research Center  
San Diego State University  
San Diego, CA 92182-7720  
<http://terminus.sdsu.edu/>

Spring 2022

(Revised: January 20, 2022)



## Outline

- 1 The Professor
  - Academic Life
  - Non-Academic Life
  - Contact Information, Office Hours
- 2 The Class — Overview
  - Literature & Syllabus
  - Grading
  - Expectations and Procedures
- 3 The Class...
  - Resources
  - Formal Prerequisites
  - Course Technology and Resources
- 4 Linear Algebra
  - The What? Why? and How?



## Academic Life

MSc



- **KTH** MSc. Engineering Physics, Royal Institute of Technology (KTH), Stockholm, Sweden. Thesis Advisers: Michael Benedicks, Department of Mathematics KTH, and Erik Aurell, Stockholm University, Department of Mathematics. Thesis Topic: “A Renormalization Technique for Families with Flat Maxima.”

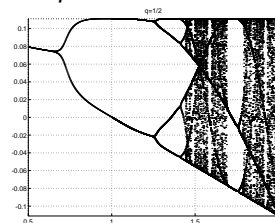

Figure: Bifurcation diagram for the family  $f_{a, \frac{1}{2}}$  [BLOMGREN-1994]



## Academic Life

PhD

- **UCLA** PhD. UCLA Department of Mathematics. Adviser: Tony F. Chan. PDE-Based Methods for Image Processing. Thesis title: “Total Variation Methods for Restoration of Vector Valued Images.”

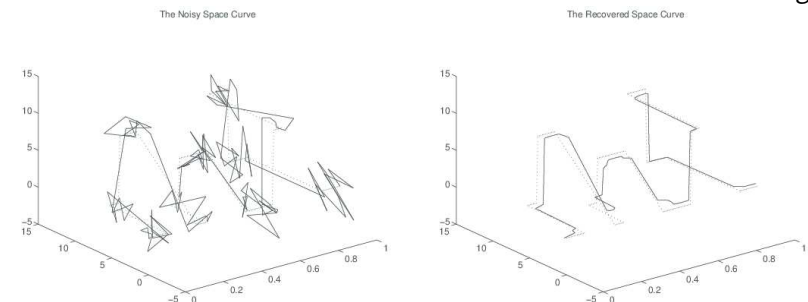



Figure: The noisy (SNR = 4.62 dB), and recovered space curves. Notice how the edges are recovered. [BLOMGREN-1998]



Academic Life

Postdoc

- 
 Research Associate. Stanford University, Department of Mathematics. Main Focus: Time Reversal and Imaging in Random Media (with George Papanicolaou, *et. al.*)

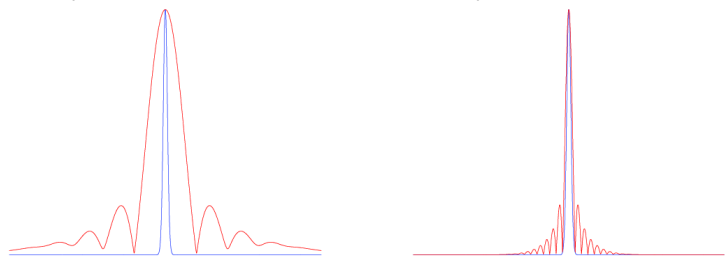

**Figure:** Comparison of the theoretical formula for a medium with  $L = 600\text{ m}$ ,  $a_e = 195\text{ m}$ ,  $\gamma = 2.12 \times 10^{-5}\text{ m}^{-1}$ . [LEFT] shows a homogeneous medium,  $\gamma = 0$ , with  $a = 40\text{ m}$  TRM (in red / wide Fresnel zone), and a random medium with  $\gamma = 2.12 \times 10^{-5}$  (in blue). [RIGHT] shows  $\gamma = 0$ , with  $a = a_e = 195\text{ m}$  (in red), and  $\gamma = 2.12 \times 10^{-5}$ , with  $a = 40\text{ m}$  (in blue). The match confirms the validity of [the theory]. [BLOMGREN-PAPANICOLAOU-ZHAO-2002]



Primary Research Interests — Current

High Performance Computing

Development of algorithms achieving near-optimal GPU utilization, with applications to Computational PDEs, Computational Linear Algebra, and Computational Optimization.

**Project #1:** *Fast Multipole Method for Waves over Vortices*, w/Chris Curtis & Daniel Matteson. (S'21)

**Project #2:** *StarPU + ScalFMM Implementation for the Fast Multipole Method*, w/Susana Munguia Hernandez. (in progress)

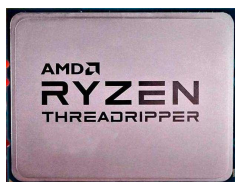

**3990x**,  $\approx \$5,500$   
64 Cores, 128 Threads.



**RTX 3090**,  $\approx \$1,499^*$   
10,496 CUDA Cores



Academic Life

Professor

- 
 Professor, SDSU, Department of Mathematics and Statistics. Projects: Computational Combustion, Biomedical Imaging (Mitochondrial Structures, Heartcell Contractility, Skin/Prostate Cancer Classification), carbon sequestration, compressed sensing.

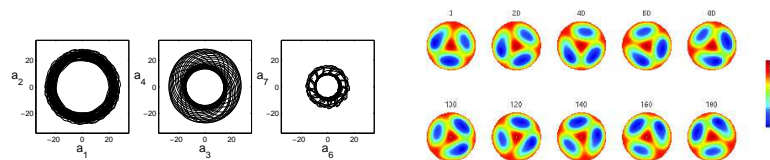

**Figure:** [LEFT] Phase-space projections produced by the time coefficients of the POD decomposition of the rotating pattern shown in [RIGHT]. [BLOMGREN-GASNER-PALACIOS-2005]



Fun Times... ⇔ Endurance Sports

Pre-Pandemic...



• Triathlons:

- (13) Ironman distance (2.4 + 112 + 26.2) [PR] 11:48:57
- (16) Half Ironman distance 5:14:20

• Running

- (1) 100k Race (62.1 miles) 15:37:46 (15:05/mi)
- (1) Trail Double-marathon (52 miles) 10:59:00 (12:32/mi)
- (5) Trail 50-mile races 9:08:46 (10:59/mi)
- (8) Trail 50k (31 mile) races 5:20:57 (10:20/mi)
- (16) Road/Trail Marathons 3:26:19 (7:52/mi)
- (30) Road/Trail Half Marathons 1:35:00 (7:15/mi)



## Contact Information



Office	Zøom and GMCS-587 (Hours on Canvas / Calendly)
Email	<a href="mailto:blomgren@sdsu.edu">blomgren@sdsu.edu</a>
Web	<a href="https://canvas.sdsu.edu">https://canvas.sdsu.edu</a> <a href="http://www.gradescope.com">http://www.gradescope.com</a> <a href="http://webwork.sdsu.edu/webwork2/math-254-blomgren">http://webwork.sdsu.edu/webwork2/math-254-blomgren</a> <a href="http://terminus.sdsu.edu/SDSU/Math254">http://terminus.sdsu.edu/SDSU/Math254</a>
Office Hours	<a href="https://calendly.com/blomgren_sdsu/">https://calendly.com/blomgren_sdsu/</a>
TA Office Hours	April Vanaria ___@sdsu.edu (Hours on Canvas)
LA Hours	Christina Soto ___@sdsu.edu (Hours on Canvas)
SI Hours	Collin Bratzler, and Hanh Nguyen <a href="http://bit.ly/math254sicalendar">http://bit.ly/math254sicalendar</a> .



## Math 254: Literature

### “Suggested” —

*Introduction to Linear Algebra*, 5th Edition, Gilbert Strang, Wellesley-Cambridge Press / Society for Industrial and Applied Mathematics, 2016. ISBN-10 0-980-23277-5, ISBN-13 978-0-980-23277-6.

### “Required”

Class notes (downloadable \$0), and class web-page; the notes will also be available for purchase (“class reader”) in the bookstore (≈ \$15–\$20)



## Math 254: Introduction — What we will cover

#	Module (Topic)	
1	Linear Equations; Vectors and Matrices <i>notes 1.1–1.4, 4 lectures.</i>	
2	Linear Transformations <i>notes 2.1–2.4, 4 lectures.</i>	Capstone #1
3	Subspaces of $\mathbb{R}^n$ and Their Dimensions <i>notes 3.1–3.4, 5 lectures.</i>	Capstone #2
5	Orthogonality and Least Squares <i>notes 5.1–5.3, 4 lectures.</i>	Capstone #3
6	Determinants <i>notes 6.1, 1 lecture.</i>	
7	Eigenvalues and Eigenvectors <i>notes 7.1–7.3, 7.E, 4 lectures.</i>	Capstone #4



## Math 254: Introduction — Grading etc.

- **Four (4) Capstone Tests** ← “Planned”
  - 20% Homework (WeBWorK), 8 assignments
  - 60% Lecture Quizzes (Gradescope, 19 quizzes)
  - 20% In-Person Capstone Tests
- Three (3) Capstone Tests
  - 25% Homework (WeBWorK), 8 assignments
  - 60% Lecture Quizzes (Gradescope, 19 quizzes)
  - 15% In-Person Capstone Tests
- Two (2) Capstone Tests
  - 30% Homework (WeBWorK), 8 assignments
  - 60% Lecture Quizzes (Gradescope, 19 quizzes)
  - 10% In-Person Capstone Tests
- One (1) Capstone Test
  - 30% Homework (WeBWorK), 8 assignments
  - 65% Lecture Quizzes (Gradescope, 19 quizzes)
  - 5% In-Person Capstone Tests
- No Capstone Tests
  - 30% Homework (WeBWorK), 8 assignments
  - 70% Lecture Quizzes (Gradescope, 19 quizzes)



## Expectations and Procedures, I

Lecture recordings will be posted (linked in Canvas);  
no-questions-asked unlimited absence policy for lectures.

- Class attendance is ( $\alpha$ ) HIGHLY RECOMMENDED — Homework and announcements will be posted in Canvas / on the class web page; ~~or ( $\beta$ ) MANDATORY for ALL in-class presentations.~~ If/when you attend class:
  - Please be on time.
  - Please pay attention.
  - Please turn “off” mobile phones.
  - Please be courteous to other students and the instructor.
  - Abide by university statutes, and all applicable local, state, and federal laws.
  - ~~(sarcasm)~~ Don't play any video games, but feel free to polish your guns~~(\sarcasm)~~



## Expectations and Procedures, II

- Please, turn in assignments on time. (The instructor reserves the right not to accept late assignments.)
- The instructor will make special arrangements for students with documented learning disabilities and will try to make accommodations for other unforeseen circumstances, e.g. illness, personal/family crises, etc. in a way that is **fair to all students enrolled in the class. Please contact the instructor EARLY regarding special circumstances.**
- Students are expected **and encouraged** to ask questions in class / **on class discussion boards!**
- Students are expected **and encouraged** to to make use of office hours! If you cannot make it to the scheduled office hours: contact the instructor to schedule an appointment!



## Expectations and Procedures, III

Four (4) in-person “Capstone Tests” planned for Spring 2022.  
Possibility: SDSU Testing Center (fee applies), if you are not comfortable taking the test in a high-capacity classroom.

- Missed midterm exams: Don't miss exams! The instructor reserves the right to schedule make-up exams, make such exams oral presentation, and/or base the grade solely on other work (including the final exam).
- Missed final exam/presentation: Don't miss the final! Contact the instructor ASAP or a grade of WU or F will be assigned.
- **Academic honesty:** submit your own work — but feel free to discuss homework with other students in the class! It's OK to ask “Uncle Google” and “Aunt Wiki” for help and ideas, but process the information and make it your own, AND cite any and all sources (outside of class material) you use.



## Honesty Pledges, I

- The following **Honesty Pledge** must be included in all programs you submit (as part of homework and/or projects):
  - I, (your name), pledge that this program is completely my own work, and that I did not take, borrow or steal code from any other person, and that I did not allow any other person to use, have, borrow or steal portions of my code. I understand that if I violate this honesty pledge, I am subject to disciplinary action pursuant to the appropriate sections of the San Diego State University Policies.
- Work missing the honesty pledge **may not be graded!**



## Honesty Pledges, II

- Larger reports must contain the following text:
  - I, (your name), pledge that this report is completely my own work, and that I did not take, borrow or steal any portions from any other person. Any and all references I used are clearly cited in the text. I understand that if I violate this honesty pledge, I am subject to disciplinary action pursuant to the appropriate sections of the San Diego State University Policies. Your signature.
- Work missing the honesty pledge may not be graded!



## Math 254: Student Learning Objectives

[NEW-ish]

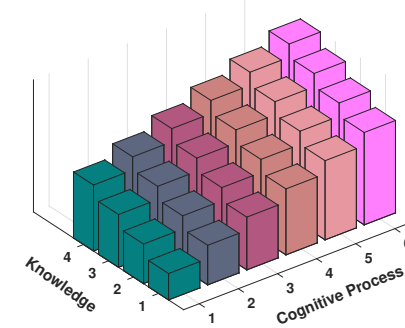

**Figure:** Now, if we think of the learning process in terms of moving upward from (1,1) = (memorize,facts) to higher levels; such as (3,3) = (perform, Gram-Schmidt Process); we can formulate more useful Student Learning Objectives.



## Math 254: Student Learning Objectives

[NEW-ish]

At the end of the semester you should (be able to)...

- (1,1) Know basic definitions of Scalars  $\in \mathbb{R}$ , Vectors  $\in \mathbb{R}^n$ , and Matrices  $\in \mathbb{R}^{m \times n}$
- (n,m) ..... [additional steps] .....
- (2,2) Understand the Geometry of Linear Transformations
- (2,2) Understand the concepts of Subspaces, Bases, and Linear Independence
- (3,3) Perform an Orthogonal Projection onto a Vector Subspace
- (3,3) Perform the Gram-Schmidt Process on a Matrix  $A$ , and identify the resulting  $Q$ - $R$  decomposition
- (3,3) Compute the Eigenvalues and Eigenvectors of a Matrix  $A$



## Math 254: Computer Resources

Optional

Some in-class demonstrations will utilize MATLAB/Python/Julia, but this class does **NOT** (yet) require any programming.

*Python "Labs" are in the making; at the start of Spring 2022 there are labs for lectures 1.1 and 1.2.*

If you want to "play" with MATLAB: — You will need access to a computing environment in which to write your code.

You may also want to consider buying the student version of Matlab: <http://www.mathworks.com/>

But why would you?!? — SDSU students can download a copy of matlab from

<http://edoras.sdsu.edu/~download/matlab.html>

[LICENSING SUBJECT TO CHANGE WITH MINIMAL NOTICE]



## Math 254: Introduction — What you should know already

Math 151 (with a minimum grade of C)

151

⇒ **Calculus II** (requires Math 150 with minimum grade of C)

- Techniques and applications of integration. Improper integrals. Differential equations. Infinite series. Conic sections. Curves in parametric form, polar coordinates.

150

⇒ **Calculus I**

- Algebraic and transcendental functions. Continuity and limits. The derivative and its applications. The integral and the fundamental theorem of calculus.



## Course Technology and Resources

- Canvas.SDSU.EDU
  - **this is the “virtual” syllabus**
  - announcements
  - lecture recordings
  - gradebook
- Terminus.SDSU.EDU
  - lecture notes (also linked from Canvas.SDSU.EDU)
  - **learning glass videos** (you will like these!)
  - $\beta$ -testing: Online interactive “labs” (optional)
- Webwork.SDSU.EDU
  - homework
- www.Gradescope.com
  - Lecture Quizzes
- lecture + office hours
- (Math Learning Center)



## Math 254: Introduction — What? Why? and How?

Let's take a step back, and ask...

*What is Mathematics?*



“The Google” has an Opinion...

...do you?!

math·e·mat·ics

/maTH(ə)'madiks/

noun

the abstract science of number, quantity, and space. Mathematics may be studied in its own right (*pure mathematics*), or as it is applied to other disciplines such as physics and engineering (*applied mathematics*).

- the mathematical aspects of something.

plural noun: mathematics

"the mathematics of general relativity"



## It's Definitely Not a Spectator Sport

### Quote

"Mathematics is not a spectator sport."

— Prof. Stanley Osher (UCLA)

... or more rudely stated:

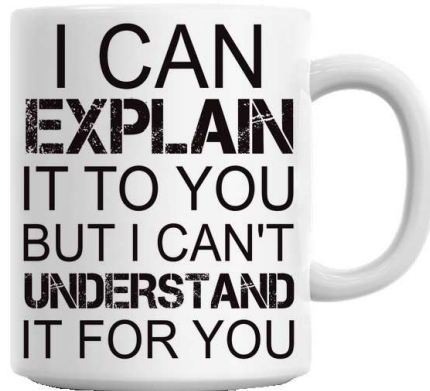

## So How \_\_\_Do\_\_\_ You Succeed in this Class?

- Actively participate by engaging with the material
  - Pay attention for more than 12.93% of the lecture(s)
  - Read
  - Think
  - Do problems
  - Get stuck (figure out what you \_\_\_don't\_\_\_ know!)
  - Think some more
  - If still stuck, get help!
    - Professor
    - "Uncle" Google & "Aunt" Wiki
    - Friends & Enemies
  - Curse the professor (it helps!) "Emotional Engagement!"
  - repeat

Also: <http://terminus.sdsu.edu/SDSU/Math254/?r=success>

