

Numerical Matrix Analysis

Notes #1 — Introduction

Peter Blomgren
(blomgren@sdsu.edu)

Department of Mathematics and Statistics
Dynamical Systems Group
Computational Sciences Research Center
San Diego State University
San Diego, CA 92182-7720

<http://terminus.sdsu.edu/>

Spring 2024

(Revised: February 19, 2024)



Outline

- 1 The Professor
 - Academic Life
 - Non-Academic Life
 - Contact Information, Office Hours
- 2 The Class — Overview
 - Literature & Syllabus
 - Grading
 - Expectations and Procedures
- 3 The Class...
 - Resources
 - Formal Prerequisites
- 4 Introduction
 - The “Why?” the “What?” and the “How?”



- MSc. Engineering Physics, Royal Institute of Technology (KTH), Stockholm, Sweden. Thesis Advisers: Michael Benedicks, Department of Mathematics KTH, and Erik Aurell, Stockholm University, Department of Mathematics. Thesis Topic: “A Renormalization Technique for Families with Flat Maxima.”

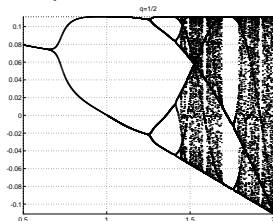

Figure: Bifurcation diagram for the family $f_{a, \frac{1}{2}}$ [BLOMGREN-1994]



- **UCLA** PhD. UCLA Department of Mathematics. Adviser: Tony F. Chan. PDE-Based Methods for Image Processing. Thesis title: “Total Variation Methods for Restoration of Vector Valued Images.”

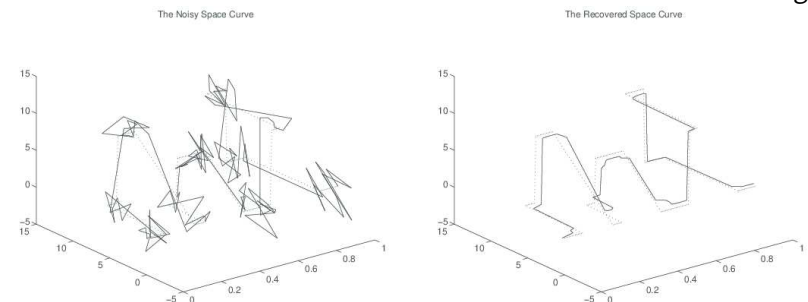



Figure: The noisy (SNR = 4.62 dB), and recovered space curves. Notice how the edges are recovered. [BLOMGREN-1998]



-  Research Associate. Stanford University, Department of Mathematics. Main Focus: Time Reversal and Imaging in Random Media (with George Papanicolaou, *et. al.*)

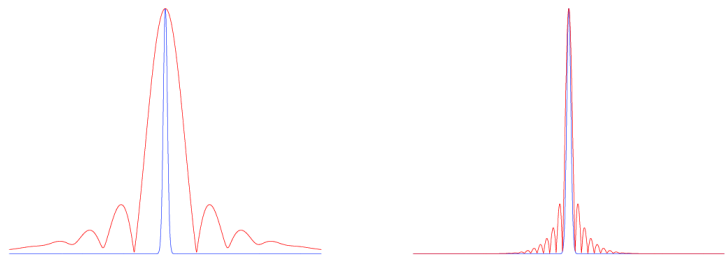

Figure: Comparison of the theoretical formula for a medium with $L = 600\text{ m}$, $a_e = 195\text{ m}$, $\gamma = 2.12 \times 10^{-5}\text{ m}^{-1}$. [LEFT] shows a homogeneous medium, $\gamma = 0$, with $a = 40\text{ m}$ TRM (in red / wide Fresnel zone), and a random medium with $\gamma = 2.12 \times 10^{-5}$ (in blue). [RIGHT] shows $\gamma = 0$, with $a = a_e = 195\text{ m}$ (in red), and $\gamma = 2.12 \times 10^{-5}$, with $a = 40\text{ m}$ (in blue). The match confirms the validity of [the theory]. [BLOMGREN-PAPANICOLAOU-ZHAO-2002]



Development of algorithms achieving near-optimal GPU utilization, with applications to Computational PDEs, Computational Linear Algebra, and Computational Optimization.

#1: *Fast Multipole Method for Waves over Vortices*, w/Chris Curtis & Daniel Matteson. (S'21)

#2: *StarPU + ScalFMM Implementation for the Fast Multipole Method*, w/..... (abandoned)

Current “Top of the Line” Hardware — Commercially “Available” CPU / GPU



Threadripper Pro 7995WX
MSRP \$9,999
96 CPU Cores, 192 Threads.



RTX 6000
MSRP \$6,800
18,176 CUDA Cores



-  Professor, SDSU, Department of Mathematics and Statistics. Projects: Computational Combustion, Biomedical Imaging (Mitochondrial Structures, Heartcell Contractility, Skin/Prostate Cancer Classification), carbon sequestration, compressed sensing.

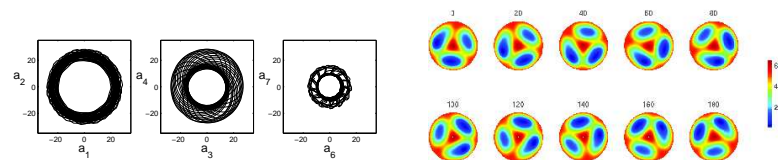

Figure: [LEFT] Phase-space projections produced by the time coefficients of the POD decomposition of the rotating pattern shown in [RIGHT]. [BLOMGREN-GASNER-PALACIOS-2005]



● Triathlons:

- (13) Ironman distance (2.4 + 112 + 26.2) [PR] 11:48:57
- (16) Half Ironman distance 5:14:20

● Running

- (1) 100k Race (62.1 miles) 15:37:46 (15:05/mi)
- (1) Trail Double-marathon (52 miles) 10:59:00 (12:32/mi)
- (5) Trail 50-mile races 9:08:46 (10:59/mi)
- (8) Trail 50k (31 mile) races 5:20:57 (10:20/mi)
- (16) Road/Trail Marathons 3:26:19 (7:52/mi)
- (30) Road/Trail Half Marathons 1:35:00 (7:15/mi)



Contact Information



Office	GMCS-415 and zoom - zoom - zoom
Email	blomgren@sdsu.edu
Web	https://canvas.sdsu.edu/ https://www.gradescope.com http://terminus.sdsu.edu/SDSU/Math543
Office Hours	https://calendly.com/blomgren_sdsu/ (see Canvas / Calendly for Hours)



The Post^(?) Pandemic Reality

2/3

- We need to remind ourselves that education is about *developing skills and processes*, definitely not just about “having The Answer.” Understanding
 - how to get The Answer;
 - how to validate The Answer;
 - what The Answer means; and
 - how The Answer potentially is useful;
 are often the bigger and more important lessons.
- It is “unlikely” that you, in real life, will be asked to differentiate $\cos(\sin(\tan(\ln(x))))$, or write the 55,000,001st analysis of Fyodor Dostoevsky’s “Crime and Punishment,” or single-handedly implement the Singular Value Decomposition... but acquiring the skills to perform these tasks are arguable useful.



The Post^(?) Pandemic Reality

1/3

- Spring 2020: We went online part-way thru the semester
- Spring 2021: Zoom-U
- Spring 2022: Masked-U — not a good semester (many reasons)
- Spring 2023: The New Normal™... some modifications.
- Spring 2024: The “AI”-era is here... and a CFA stike is planned.

During COVID we all de-socialized to some extent; and there is definitely a “learning gap.”

There is sometimes a tendency to see all this silly learning and class work as unnecessary obstacles to getting a degree.

... which leads to the temptation of taking the path of least resistance and have Uncle Google, Aunt Wiki, Scuzzy Cousin Chegg, Skynet, or ChatGPT do all the heavy lifting... in a lazy way.



The Post^(?) Pandemic Reality

3/3

New AI-era Policies — SPRING 2024

AI-3 Documented: *Students can use AI in any manner for this assessment or deliverable, but they must provide appropriate documentation for all AI use.*

This applies to ALL MATH-543 WORK during the SPRING 2024 semester.

The goal is to leverage existing tools and resources to generate HIGH QUALITY SOLUTIONS to all assessments.

You MUST document what tools you use and HOW they were used (including prompts); AND how results were VALIDATED.

BE PREPARED to DISCUSS homework solutions and AI-strategies. **Participation in the in-class discussions will be an essential component of the grade for each assessment.**



Math 543: Literature

“Required” —

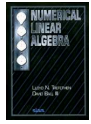

Numerical Linear Algebra, Lloyd N. Trefethen and David Bau, III, Society for Industrial and Applied Mathematics (SIAM*), 1997. ISBN 978-0-898713-61-9.

Also: Twenty-fifth Anniversary Edition, Society for Industrial and Applied Mathematics (SIAM), 2022. ISBN: 978-1-611977-15-8

“Required” — (Supplemental)

Class notes and class web-page.

* SIAM members receive special pricing (30% off). SIAM student membership is free.



Math 543: Literature

“Inspiration for the Road Ahead” —

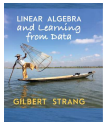

Linear Algebra and Learning From Data, Gilbert Strang, Society for Industrial and Applied Mathematics (SIAM*), 2019. ISBN 978-069219638-0.

“Considered... but, no.” —



Matrix Methods in Data Mining and Pattern Recognition, Second Edition, Lars Eldén, Society for Industrial and Applied Mathematics (SIAM*), 2019. ISBN: 978-1-611975-85-7.

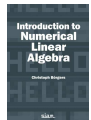

Introduction to Numerical Linear Algebra, Christoph B rger, Society for Industrial and Applied Mathematics (SIAM*), 2022. ISBN: 978-1-61197-691-5.

* SIAM members receive special pricing (30% off). SIAM student membership is free.



Math 543: Literature

Everything You Ever Wanted to Know, but Were Afraid to Ask...

“Optional” — (Classic, Comprehensive Reference)



Matrix Computations, 4th Edition, Gene H. Golub and Charles F. Van Loan, Johns Hopkins University Press, 2012. ISBN-13 978-1421407944.

“Optional” — (Comprehensive Reference)

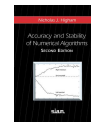

Accuracy and Stability of Numerical Algorithms, Second Edition, Nicholas J. Higham, Society for Industrial and Applied Mathematics (SIAM*), 2002. ISBN 978-0-898715-21-7.

* SIAM members receive special pricing (30% off). SIAM student membership is free.



Math 543: Introduction — Grading etc.

50% Homework: both theoretical, and implementation (programming) — Recommended languages: Python, Matlab, C/C++, or Fortran; however anything goes: 6510 assembler, Java, M\$-D^b, Haskell...

25% Midterm: [$\frac{1}{2}$ Take-Home, and $\frac{1}{2}$ In-Class].

25% Final: [$\frac{1}{2}$ Take-Home, and $\frac{1}{2}$ In-Class].



Expectations and Procedures, I

- Most class attendance is “OPTIONAL” — Homework and announcements will be posted on the class web page. If/when you attend class:
 - Please be on time.
 - Please pay attention.
 - Please turn “off” mobile phones.
 - Please be courteous to other students and the instructor.
 - Abide by university statutes, and all applicable local, state, and federal laws.
 - **Spring 2024:** Note that participation in in-class discussions of assignments is REQUIRED. Discussions will take place approximately 1 week after the deadline for each assignment.



Expectations and Procedures, II ^I/_{II}

Updated Spring 2022

Late HW Policy

- Assignments accepted up to 24 hours after original deadline, with a 10% penalty.
- Further extensions will only be granted in extreme, well-documented, circumstances.



Expectations and Procedures, II

- Please, turn in assignments on time. (The instructor reserves the right not to accept late assignments.)
- The instructor will make special arrangements for students with documented learning disabilities and will try to make accommodations for other unforeseen circumstances, e.g. illness, personal/family crises, etc. in a way that is fair to all students enrolled in the class. **Please contact the instructor EARLY regarding special circumstances.**
- Students are expected **and encouraged** to ask questions in class!
- Students are expected **and encouraged** to to make use of office hours! If you cannot make it to the scheduled office hours: contact the instructor to schedule an appointment!



Expectations and Procedures, III

- Missed midterm exams: Don't miss exams! The instructor reserves the right to schedule make-up exams, make such exams oral presentation, and/or base the grade solely on other work (including the final exam).
- Missed final exam: Don't miss the final! Contact the instructor ASAP or a grade of incomplete or F will be assigned.
- **Academic honesty:** submit your own^(*) work — but feel free to discuss homework with other students in the class!

(*) see also AI-policies for the class.



Honesty Pledges, I

- The following **Honesty Pledge** must be included in all programs you submit (as part of homework and/or projects):
 - I, [your name], pledge that this program is completely my own work, and that I did not take, borrow or steal code from any other person — real or artificial — and that I did not allow any other person to use, have, borrow or steal portions of my code. **I have adhered to the AI-policies of the course, and have appropriately and completely documented any and all use of AI-tools.** I understand that if I violate this honesty pledge, I am subject to disciplinary action pursuant to the appropriate sections of the San Diego State University Policies.
- Work missing the honesty pledge **may not be graded!**



Math 543: Computer Resources

You need access to a computing environment in which to write your code; — you may want to use any combination of Matlab (for quick prototyping and short homework assignments) and other languages; e.g. Python, C/C++ or Fortran (or something completely different, like Java or M\$-D^b).

Free C/C++ and Fortran compilers are available for Linux/UNIX.

SDSU students can download a copy of matlab from

<https://www.mathworks.com/academia/tah-portal/san-diego-state-university-1108597.html>

[LICENSING SUBJECT TO CHANGE WITH MINIMAL NOTICE]



Honesty Pledges, II

- Larger reports must contain the following text:
 - I, [your name], pledge that this report is completely my own work, and that I did not take, borrow or steal any portions from any other person — real or artificial — and that I did not allow any other person to use, have, borrow or steal portions of my report. Any and all references I used are clearly cited in the text. **I have adhered to the AI-policies of the course, and have appropriately and completely documented any and all use of AI-tools.** I understand that if I violate this honesty pledge, I am subject to disciplinary action pursuant to the appropriate sections of the San Diego State University Policies. [Your signature].
- Work missing the honesty pledge may not be graded!



Math 543: Introduction — What you should know already

Prerequisite: Math 340

340 ⇒ **Programming in Mathematics**

- Introduction to programming in mathematics. Modelling, problem solving, visualization..

Prerequisite: Math 254 or Math 342A or AE 280

254 ∩ 342A ∩ AE 280 ⇒ **Basic Linear Algebra**

- Vectors, Matrices, Eigenvalues and Eigenvectors

$$\vec{x} = \begin{bmatrix} x_1 \\ x_2 \\ \vdots \\ x_n \end{bmatrix}, \quad A = \begin{bmatrix} a_{11} & a_{12} & \dots & a_{1n} \\ a_{21} & a_{22} & \dots & a_{2n} \\ \vdots & \vdots & \ddots & \vdots \\ a_{n1} & a_{n2} & \dots & a_{nn} \end{bmatrix} = [\vec{a}_1 \quad \vec{a}_2 \quad \dots \quad \vec{a}_n]$$



Math 543: Introduction — Why???

Solution of linear systems and eigenvalue problems show up in many applications in applied & computational mathematics / sciences / engineering.

Although we probably know about Gaussian Elimination for solving

$$\vec{x} = A^{-1}\vec{b}, \quad \text{where } A \in \mathbb{R}^{n \times n}, \vec{x}, \vec{b} \in \mathbb{R}^n$$

in infinite precision (by hand), finding this solution (or at least a good approximation thereof) in **finite precision** (i.e. on a computer) is sometimes a challenge — especially if we need the solution fast...



Math 543: Introduction — Why???

The computational complexity (number of operations needed) for Gaussian Elimination is $\mathcal{O}(n^3)$, which is quite slow as n grows “large.”

Applications (sources of Numerical Linear Algebra problems):

- Solution of partial differential equations (PDEs)
- Optimization (Operations Research)
- Model Analysis and Fitting (Least Squares)
- Image Processing
- Protein Folding
- DNA sequencing, etc. etc. etc.
- **Data Science, Machine Learning, AI, etc...**



Math 543: Introduction — What We Will Discuss

$$A\tilde{x} = \tilde{b}, \quad A\tilde{x} = \lambda\tilde{x}, \quad Q^T A Q = \Lambda = \text{diag}(\lambda_1, \lambda_2, \dots, \lambda_n), \quad A = U\Sigma V^*$$

- QR-Factorization / Least Squares
- The Singular Value Decomposition
- Conditioning and Stability
- Gaussian Elimination, Pivoting
 - ⇒ LU- and Cholesky-factorization
- Eigenvalue Problems
- Iterative Methods
 - ⇒ Arnoldi, GMRES, Lanczos, Conjugate Gradients

